

Monteringsanvisning väggskivor - steg 1-6

Installation instruction wall panel step 1-6

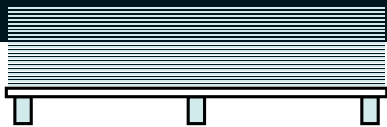

Lagring | Storage

Förvara skivorna i förpackning tills montering.

Keep panels stored flat in package until installation.

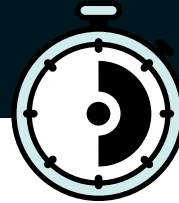

72 timer | 72 hours

Akklimatisera förpackade paneler i rumsförhållanden i minst 72 timmar (mer om de har varit i kylförvaring)

Store panels in package in room conditions for at least 72 hour acclimation (longer if they have been kept in a cold area).

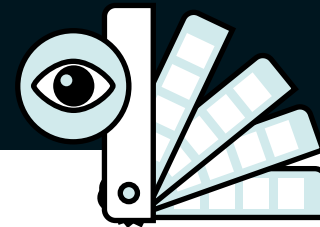

Visuell kontroll | Visual control

Kontrollera färg och kolla efter andra fel före montering.

Colourmatch and check for flaws before installation.



The smart way to transform your wall

För att säkerställa hållbarheten hos dina väggar i årtionden, är Fibo väggskiva tillverkad med 7-lager björk plywood kärna mellan balanslaminat och ett dekorativt högtrycks-laminat som är lätt att rengöra och underhålla. Fibo Aqualock ger enkel installation och ett hållbart resultat.

To ensure that your walls are durable enough to last decades, Fibo wall panels are made from a seven layer marine plywood core layered between a backing laminate and a decorative high pressure laminate surface that is easy to clean and maintain. Fibo Aqualock makes the installation easy and provide a consistent result.



1

VÄLJ RÄTT KONSTRUKTION * BACKWALL OPTIONS *

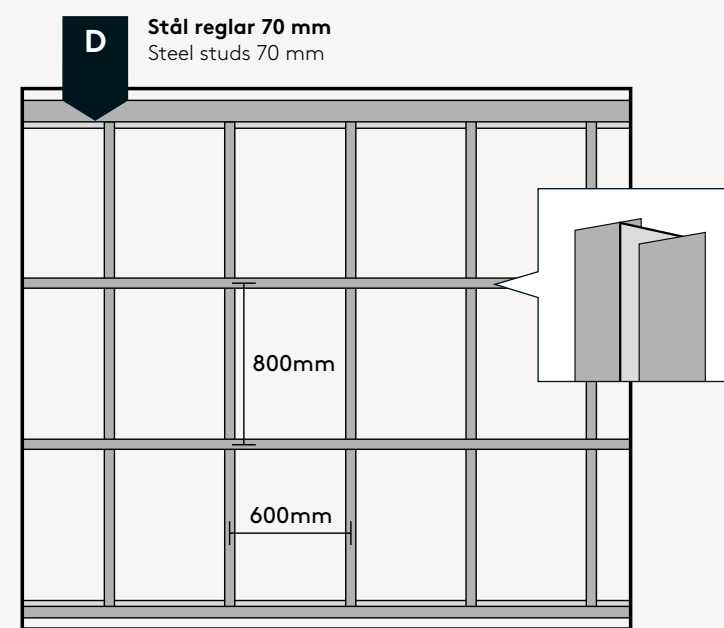
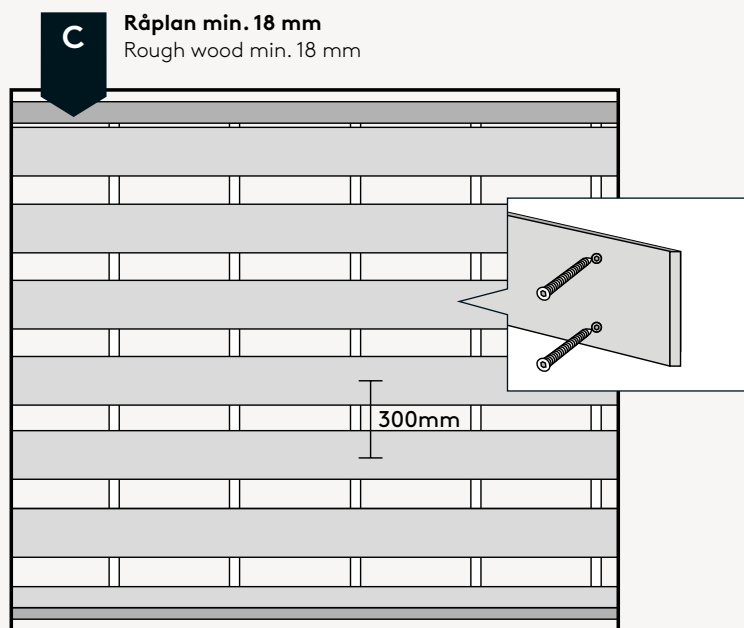
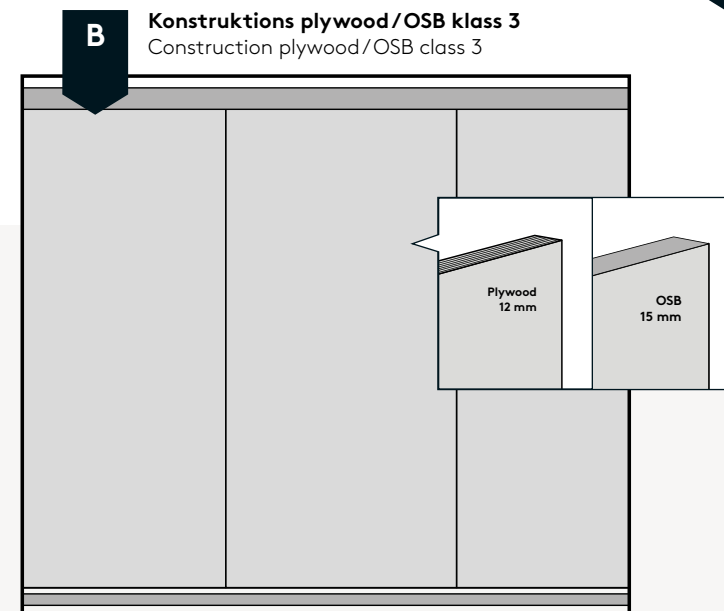
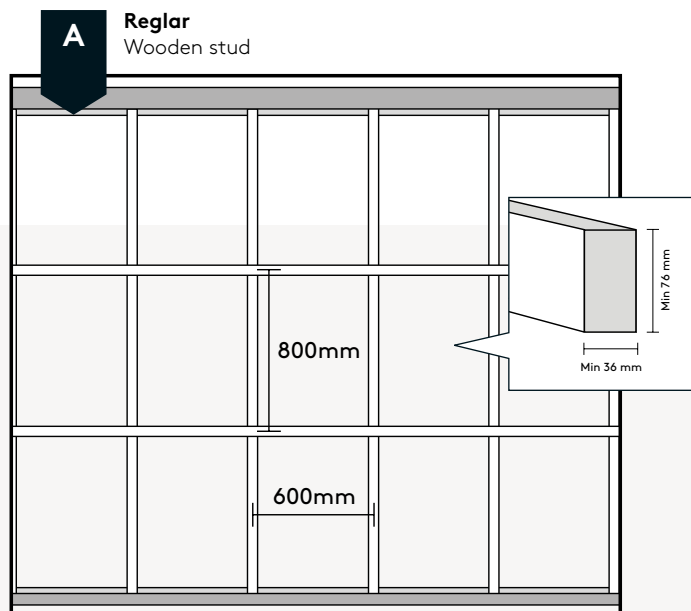

3

VERKTYG DU BEHÖVER | TOOLS YOU NEED

Batteriborr med T10-bit och borr
Screwdriver with T10 bit and drill

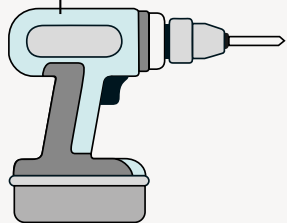

Tandsåg eller cirkelsåg
Track saw or Circular saw

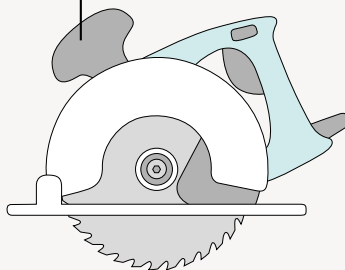

Hålsåg/Sticksåg för duschhuvud/rör genomföring
Hole saw/Jigsaw for shower heads/pipe penetrations

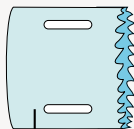

Penna
Pencil

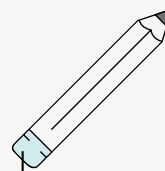

Linjal eller måttband
Ruler or measuring tape

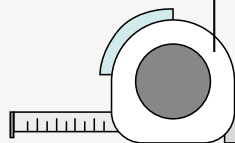

Nivå eller laser
Level or laser

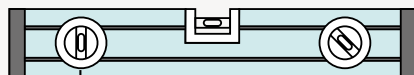

SKÄR SKIVOR CUTTING PANELS

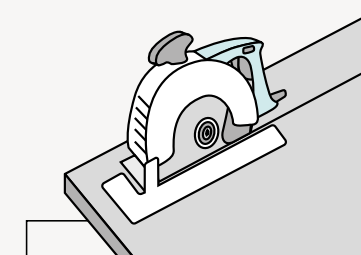

Dekorsidan nedåt
Decorside facing down

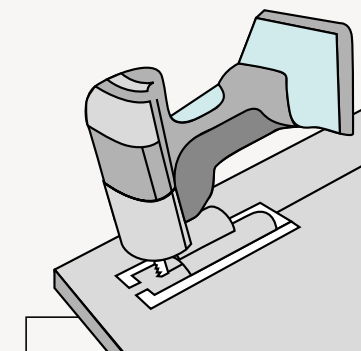

Dekorsidan nedåt
Decorside facing down

FIBO TILLBEHÖR | FIBO ACCESSORIES



Fibo ersätter ångspärr på ytterväggen när alla övergångar är förseglade.

Fibo replaces vapor barrier when all joints are sealed.

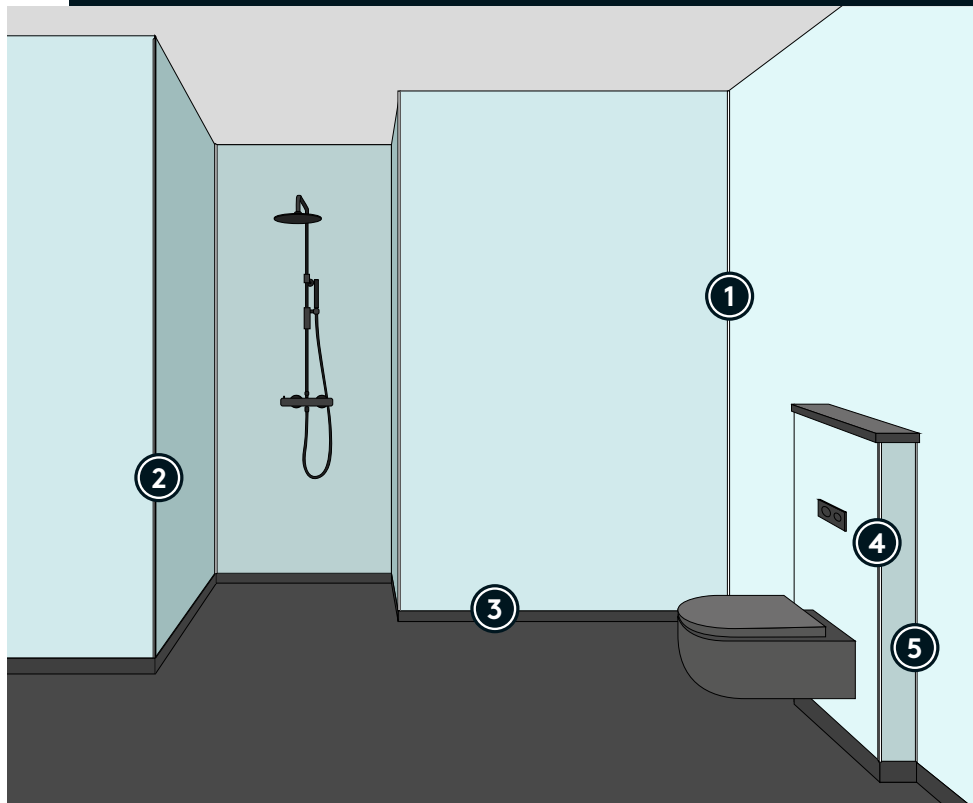

FIBO PROFILER | FIBO PROFILES

Internal Corner Profiles

1



2-delad invändig hörnprofil
2-part Internal Corner profile



Dold hörnprofil
Hidden Internal Corner profile



Standard invändig Hörnprofil II
Standard Internal Corner profile II

External Corner

2



Utvändig hörnprofil II
External Corner profile II

Base Profile

3



Sockelprofil
Base profile

L-Profiles

4



L-profil II Smal
L-profile II Small



L-profil II Bred
L-profile II Wide

Combi Profile

5

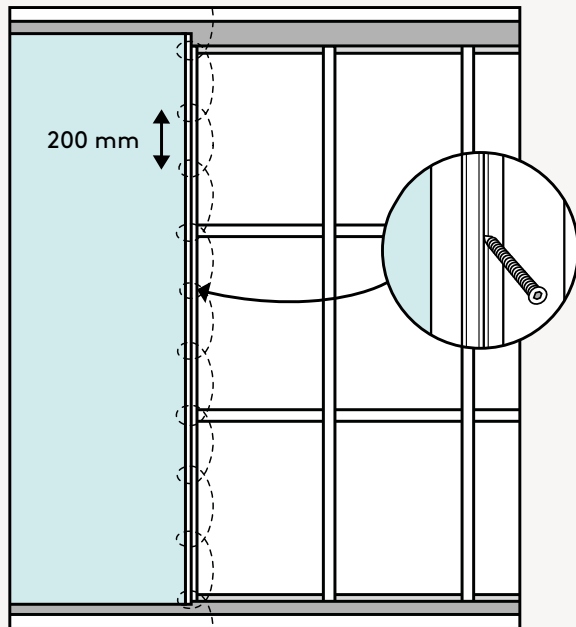

Combiprofil
Combi profile

Montering med Fibo skruvar
Installation with Fibo Screws

Max skruv avstånd i klick: 200 mm.
Max. screw distance in click: 200 mm.

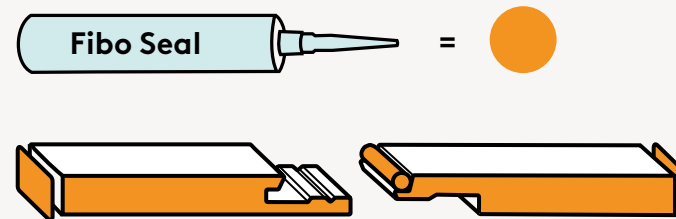
**HUR MAN FOGAR FIBO VÄGGSKIVOR**

För vattentätt system, applicera Fibo Seal enligt nedan. Alla sågade ytor måste också fogas och även vid borrning av hål för rör genomföring. I händelse av felaktig installation upphör garantin. Använd Fibo Clean och Fibo Wipes för att ta bort överflödigt fogmassa. Film från rengöringstillbehör bör avlägsnas omedelbart från skivorna.

HOW TO SEAL FIBO WALL PANELS

For watertight system, apply Fibo Seal as shown beneath. All cutting surfaces must be sealed, also when drilling holes for pipe penetration. Incorrect installation will void your warranty. Use Fibo Clean and Fibo Wipes to remove excessive sealant. Film from cleaning accessories shall be removed immediately from panel surface.

3 AVSLUTNING MOT GOLVMEMBRAN CHOOSE TRANSITION TO FLOOR MEMBRANE

Alternativ A och B är allmänt godkända lösningar, testade i enlighet med ETAG 022.
Alternative A and B are universal approved solutions, tested according to ETAG 022.

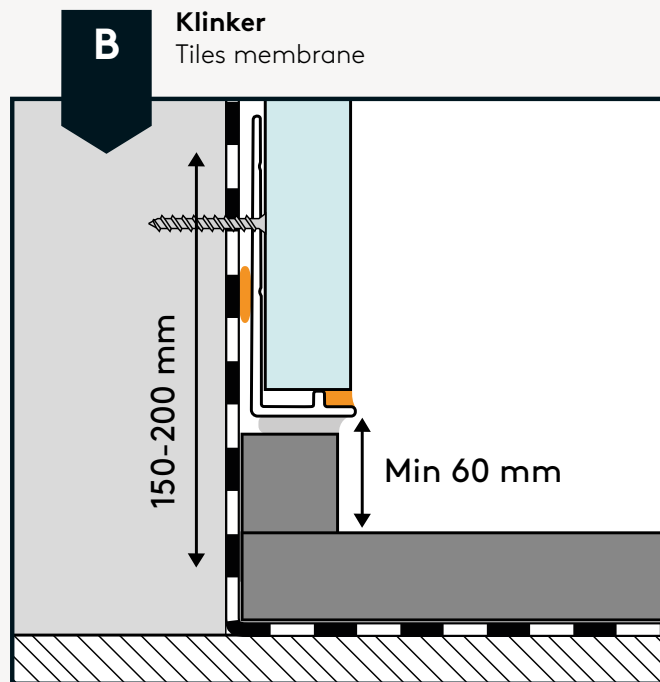
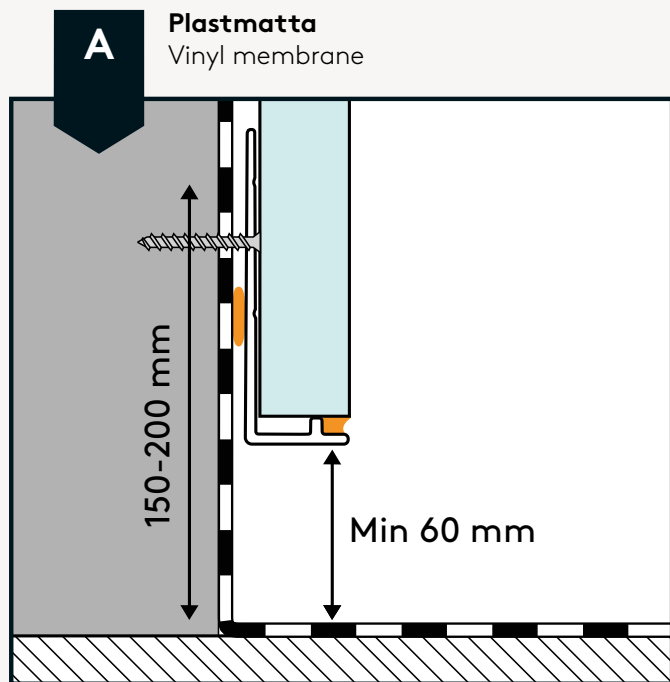

4

VÄLJ HÖRNPROFIL A ELLER B
CHOOSE CORNER PROFILE A OR B

A

2-DELAD INVÄNDIG HÖRNPROFIL

2-PART INTERNAL CORNER PROFILE

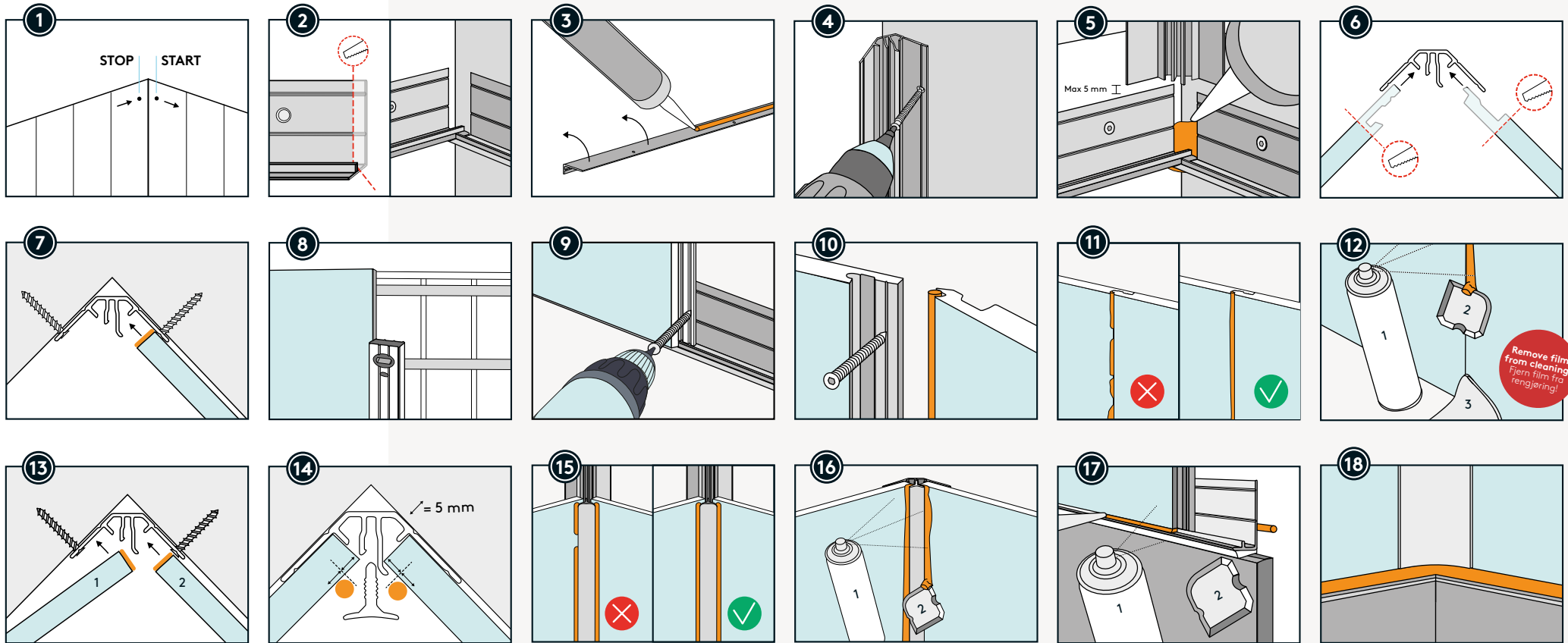
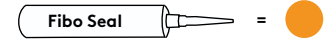

Do not place corner profile further down than this.

4

VÄLJ HÖRNPROFIL A ELLER B
CHOOSE CORNER PROFILE A OR B

B

DOLD INVÄNDIG HÖRNPROFIL

HIDDEN INTERNAL CORNER PROFILE

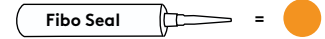

Profile Tape =

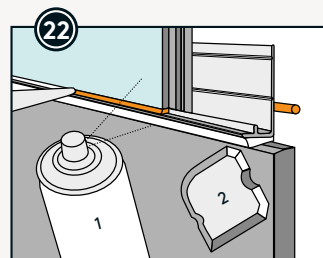
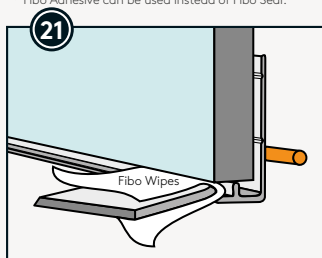
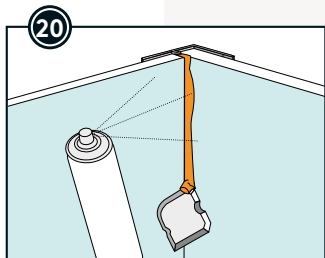
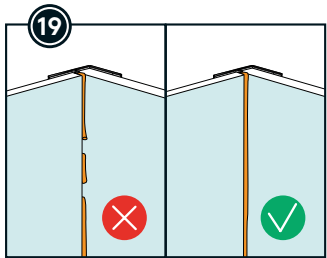
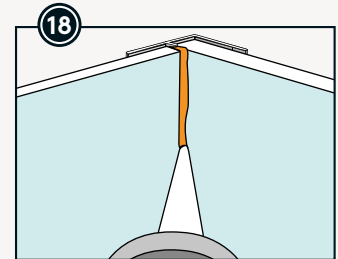
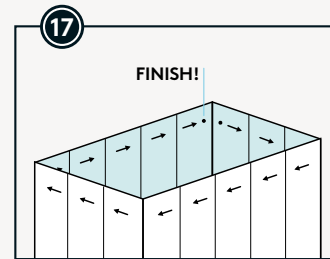
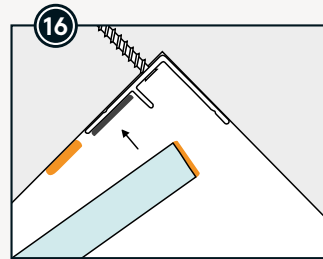
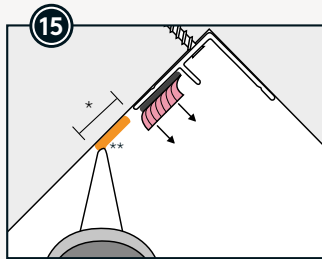
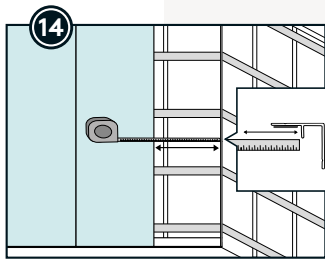
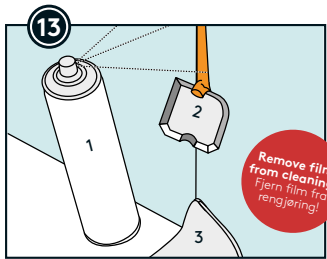
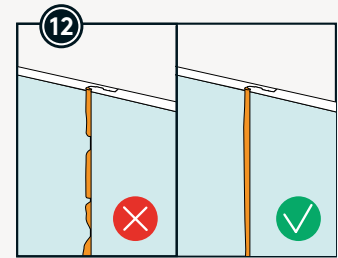
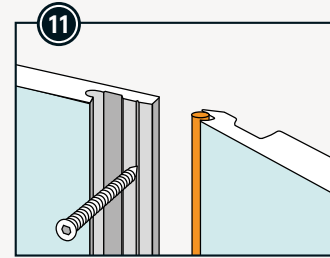
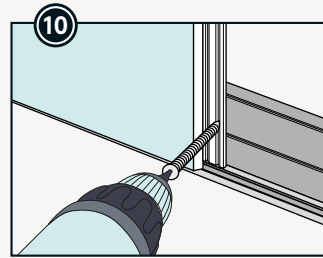
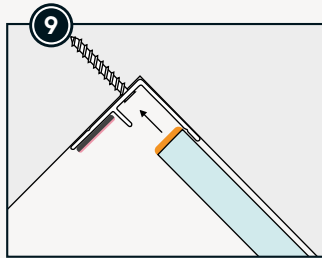
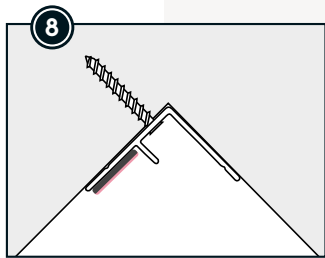
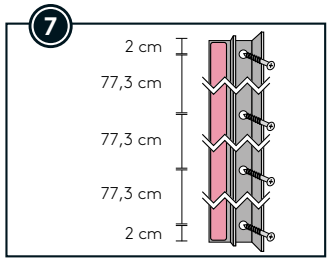
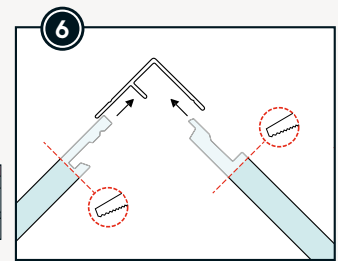
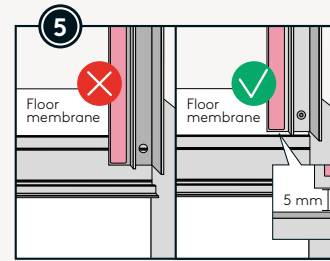
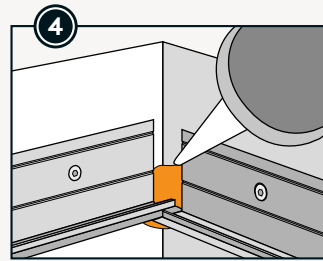
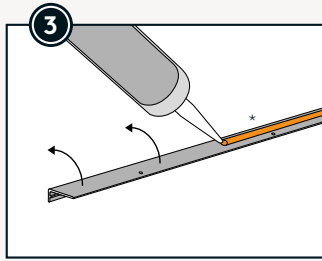
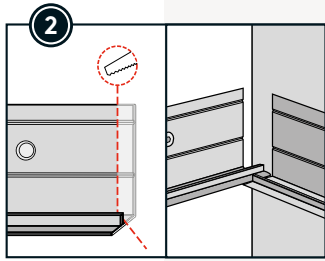
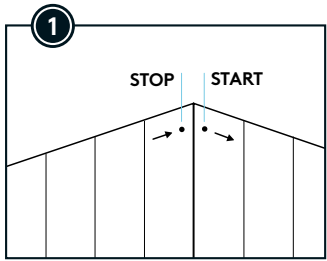

* Fibo Adhesive can be used instead of Fibo Seal.

* If backwall with strips, bead must be 18 mm.
With board backwall the bead should be 6 mm.
** Fibo Adhesive can be used instead of Fibo Seal.

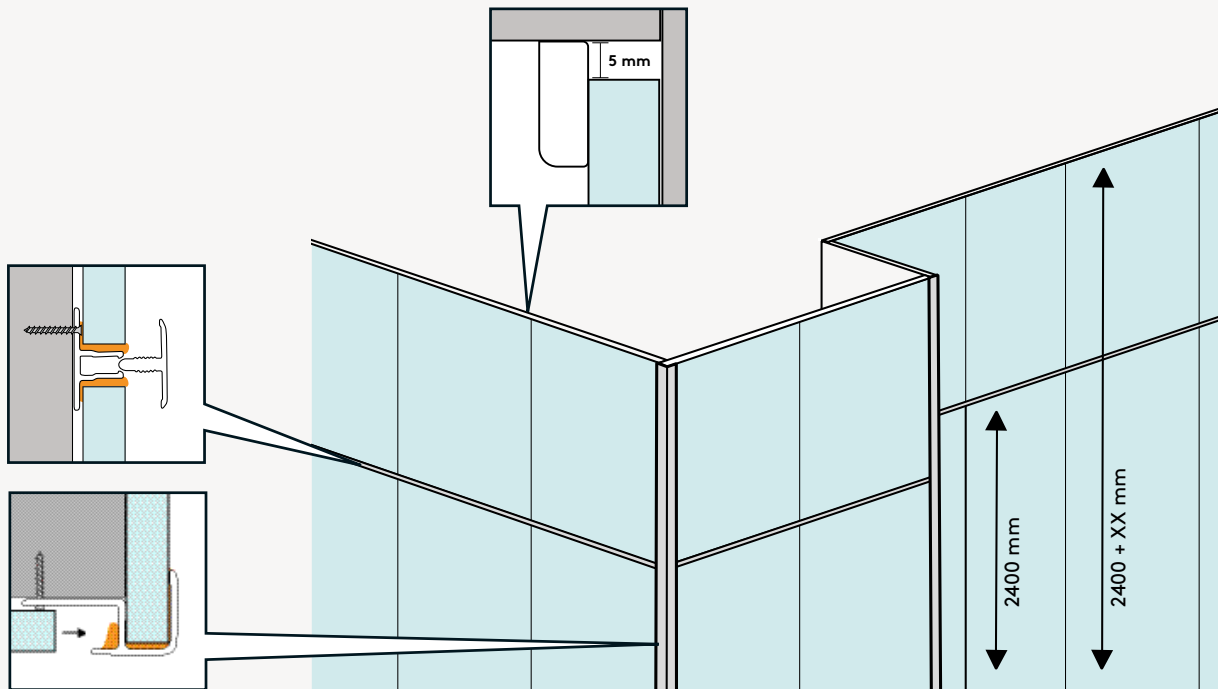
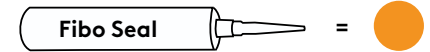

HUR MAN TÄTAR SKRUVHÅL HOW TO SEAL SCREW WHOLES

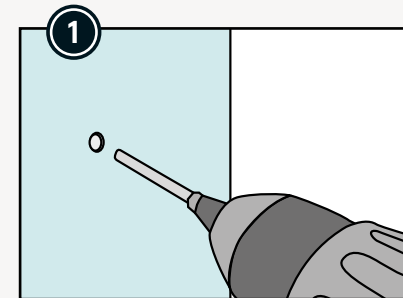

Borra ett 5 mm djupt hål i samma dimension som skruven.

Drill a 5 mm deep hole in the same dimension as the screw.

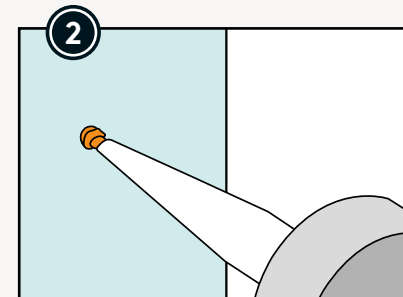

Fyll hålet med Fibo Seal.

Fill the hole with Fibo Seal.

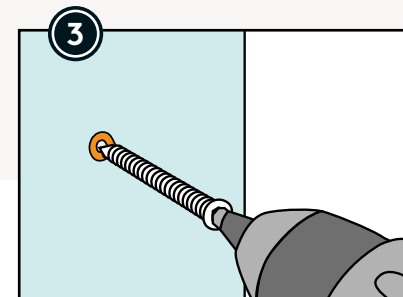

Använd VVS-skruv.

Use VVS screws.

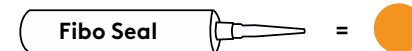

Sågade ytor måste tätas vid borrning av hål för rör genomföring. För fullständiga installationsanvisningar för ETAG 022-godkända lösningar, följ tillverkarens instruktioner för väggboxar. Godkännande av PP- och kopparrör är dokumenterat i SINTEF Technical Approval 2289.

Cutting surfaces must be sealed when drilling holes for pipe penetration. For complete installation guidance, follow the wall box producers' instructions. The ones illustrated are ETAG 022 approved systems. Approval for PP- and copper pipes is documented through SINTEF Technical Approval 2289.

Första steg vid alla tillfällen
First step in all cases

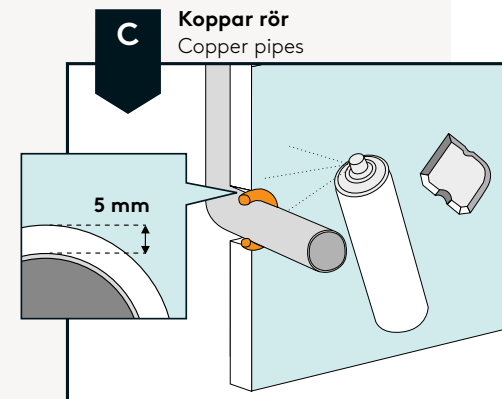
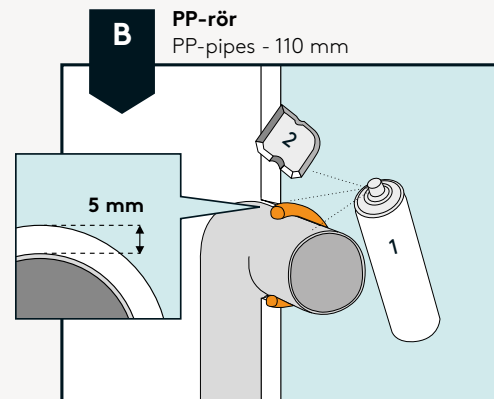
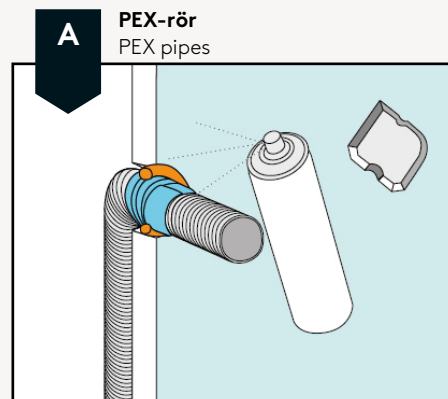
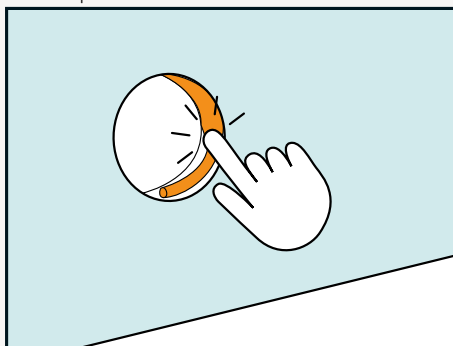

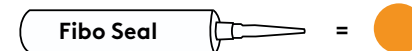

Sågade ytor måste tätas vid borring av hål för rör genomföring. För fullständiga installationsanvisningar för ETAG 022-godkända lösningar, följ tillverkarens instruktioner för väggboxar. Godkännande av PP- och kopparrör är dokumenterat i SINTEF Technical Approval 2289.

Cutting surfaces must be sealed when drilling holes for pipe penetration. For complete installation guidance, follow the wall box producers' instructions. The ones illustrated are ETAG 022 approved systems. Approval for PP- and copper pipes is documented through SINTEF Technical Approval 2289.

First step in all cases

